



# HOSHIZAKI

## CF 45 SG UK CHEST FREEZER

PRODUCT SERIES: CF  
ITEM NUMBER: 813949016  
COUNTRY OF ORIGIN: DENMARK



Hydro Carbon Chest Freezer equipped with lift up stainless lid, handle and lock, defrost water drain complete with 2 wire baskets. It has a gross volume of 416Ltr.

- Adjustable thermostat, power indicator
- Stainless steel lid
- Lockable handle
- Protected drain to reduce blockages
- Supplied on castors as standard
- Exterior: White
- Interior: Hammered aluminium

### ACCESSORIES INCLUDED

2 wire baskets

#### WARRANTY PERIOD

**3 Years on Parts & Labour**

#### EXTERIOR

**White Finish**

#### INTERIOR

**Hammered aluminium**

Refrigerant type: R600a

Energy consumption	Energy efficiency class
584 kWh	C

#### CERTIFICATIONS





# HOSHIZAKI

## CF 45 SG UK

### TECHNICAL SPECIFICATIONS

Temperature range	Volume, gross	Net usable volume	Power supply	Connection load	Sound level
-22/-14°C	416 l	361 l	230V, 50 Hz	146 kW	49 dB(A)

### SHIPPING SPECIFICATIONS

Width (packed)	Depth (packed)	Height (packed)	Volume (packed)	Width	Depth	Height	Net weight
1,550 mm	760 mm	940 mm	1.107 m <sup>3</sup>	1,300 mm	730 mm	900 mm	64 kg

Disclaimer: Every effort has been made to ensure that the information contained in this spec sheet is accurate at the time of publishing. Hoshizaki Europe BV assumes no responsibility or liability for typographical errors or omissions or for any misinterpretation of the information within the publication and reserves the right to change without notice.

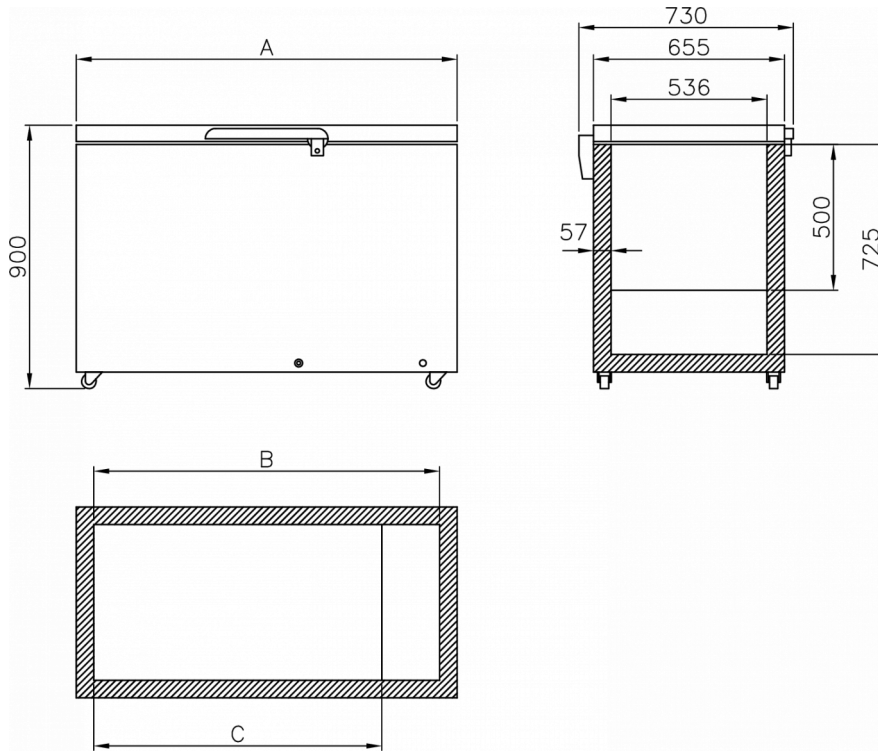

Model	A	B	C
CF 35	1050	936	736
CF 45	1300	1186	986
CF 53	1500	1386	1186
CF 61	1700	1586	1386



Hoshizaki Belgium  
 Hoshizaki Danmark  
 Hoshizaki Deutschland  
 Hoshizaki France  
 Hoshizaki Iberia  
 Hoshizaki Italia  
 Hoshizaki Middle East

[info@hoshizaki.nl](mailto:info@hoshizaki.nl)  
[info@hoshizaki.dk](mailto:info@hoshizaki.dk)  
[vertrieb@hoshizaki.de](mailto:vertrieb@hoshizaki.de)  
[info@hoshizaki.fr](mailto:info@hoshizaki.fr)  
[info@hoshizaki.es](mailto:info@hoshizaki.es)  
[commerciale@hoshizaki.it](mailto:commerciale@hoshizaki.it)  
[sales.ex@hoshizaki-europe.com](mailto:sales.ex@hoshizaki-europe.com)

Hoshizaki Netherlands [info@hoshizaki.nl](mailto:info@hoshizaki.nl)  
 Hoshizaki Norge [salg@hoshizaki.no](mailto:salg@hoshizaki.no)  
 Hoshizaki Sverige [orderSE@hoshizaki.dk](mailto:orderSE@hoshizaki.dk)  
 Hoshizaki UK [uksales@hoshizaki.uk](mailto:uksales@hoshizaki.uk)  
 Export countries [sales.ex@hoshizaki-europe.com](mailto:sales.ex@hoshizaki-europe.com)  
 Other countries [sales.ex@hoshizaki-europe.com](mailto:sales.ex@hoshizaki-europe.com)

[www.hoshizaki.uk](http://www.hoshizaki.uk)